

Data Sheet iSYS-6003 (UART)

Version 1.2 - 29.11.2016



PRODUCT FAMILY

60GHz Distance Measurement System

APPLICATIONS

- Level Measurement
- Industrial Applications

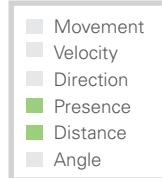

FEATURES:

- » radar-based distance measurement system working between 57 GHz and 64 GHz
- » Distance measurement with millimeter accuracy
- » Small size (50mm x 50mm) for easy integration into customer housing
- » Detection range configurable
- » Small 3dB beamwidth of approx. 8 deg (azimuth and elevation)
- » 3 configurable outputs for control

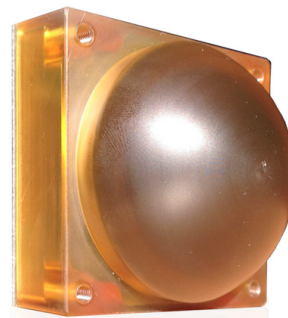

DESCRIPTIONS

60 GHz radar sensor with intelligent μ C preprocessing unit to detect targets and measure their distance to the sensor.

The sensor provides 3 programmable output pins that offer a wide area of individual configurations, to make sure that the sensor fits to your individual requirements.

InnoSenT provides solutions (schematic and layout) to the customer in order to realize RS-485, USB (RS-232) or 4-20mA current interface for the sensor.

CERTIFICATES

InnoSenT GmbH has established and applies a quality system for: development, production and sales of radar sensors for industrial and automotive sensors.



ADDITIONAL INFORMATION

InnoSenT Standard Product. Changes will not be notified as long as there is no influence on form, fit and within this datasheet specified function of the product.

RoHS-INFO

This product is compliant to the restriction of hazardous substances (RoHS - European Union directive 2011/65/EU).

CONFIDENTIAL AND PROPRIETARY

The information contained in this document shall remain the sole and exclusive property of InnoSenT GmbH and shall not be disclosed by the recipient to third parties without prior consent of InnoSenT in writing.

ELECTRICAL CHARACTERISTICS

PARAMETER	CONDITIONS	SYMBOL	MIN	TYP	MAX	UNITS
-----------	------------	--------	-----	-----	-----	-------

Radar

transmit frequencies		f_t	57		64	GHz
output power (EIRP)		P_{out}			10	dBm

Sensor

detection distance	depending on RCS of target	d_r	0.12		20	m
accuracy	depending on the surface of the illuminated object			± 2		mm
resolution	two targets with equal RCS	Δd		12		cm
standard detection field	compare with plot on page 4	horizontal		8		°
		vertical		8		°
rise time of device	Sensor ready for communication				220	msec

Power supply

supply voltage		V_{CC}	4.8		5.2	V
supply current		I_{CC}		520		mA

Digital output Current

OUT 1	Digital output	I_{Out}	-4		4	mA
OUT 2	Digital output	I_{Out}	-4		4	mA
OUT 3	Digital output	I_{Out}	-4		4	mA
STATUS	Digital output	I_{Out}	-4		4	mA

Environment

operating temperature		T_{OP}	-25		+60	°C
storage temperature		T_{STG}	-25		+60	°C

Mechanical Outlines

outline dimensions	compare to schematic on page 3	height length width		47.7 50.5 50.5		mm
--------------------	--------------------------------	---------------------------	--	----------------------	--	----

CONFIDENTIAL AND PROPRIETARY

The information contained in this document shall remain the sole and exclusive property of InnoSenT GmbH and shall not be disclosed by the recipient to third parties without prior consent of InnoSenT in writing.

MEASUREMENT MODES

Depending on your needs the iSYS-6003 offers two measurement modes to fit perfectly to your application.

PARAMETER	CONDITIONS	SYMBOL		UNITS
Multitarget Mode				
number of targets	38400kb/s or higher baud rate ⁽¹⁾		30	targets
Update rate			5	Hz
Output format			Single target or target list	
Single Target Mode				
Update rate			20	Hz
Output format			Single target	

⁽¹⁾ The Default baud rate is 115200kb/s

MECHANICAL OUTLINES

For mounting the module we recommend to use DIN 7991 / ISO 10642 M3 x (5mm + mounting plate strength)

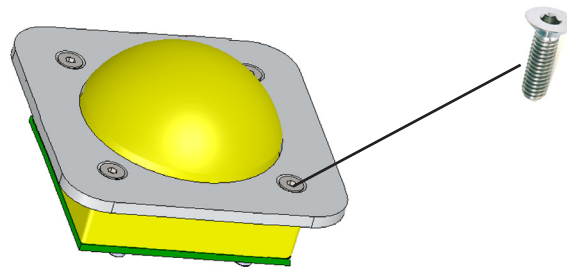

top view

Threaded bush (4x)
DIN 16903 Form U-M3
DIN EN 12164 - CuZn39Pb3

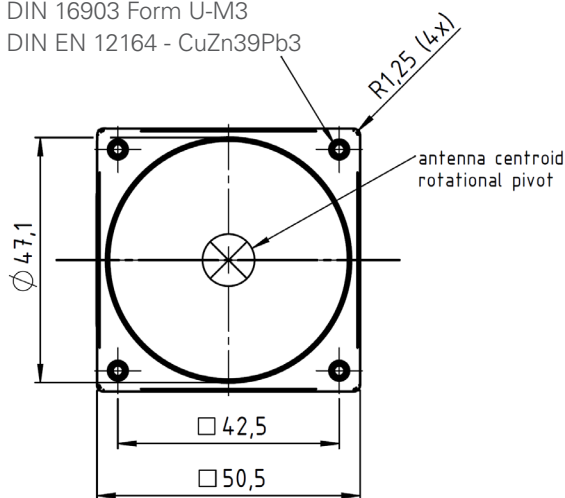

side view

Label content:
iSYS-6003
S/N: 8-digit
DataMatrixCode

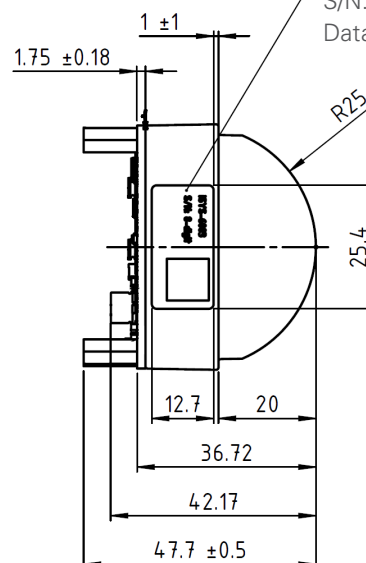

CONFIDENTIAL AND PROPRIETARY

The information contained in this document shall remain the sole and exclusive property of InnoSenT GmbH and shall not be disclosed by the recipient to third parties without prior consent of InnoSenT in writing.

DETECTION FIELDS

Something about detection fields: Providing the width of the antenna in degrees just says, that the transmitted or received energy has dropped at this point down to 50 percent of the maximum value (3dB-beamwidth). It does definitely not mean that beyond that point no transmission or reception is possible anymore. An object for instance with huge radar cross section (truck, metallic door) might very well compensate the loss of the antenna pattern and provide a significant radar signal. Due to this fact the detection range of the sensor can vary depending on the RCS (radar cross section) of the detected object. The schematics below show the transmit patter @ 61 GHz.

Azimuth (measured @61GHz)

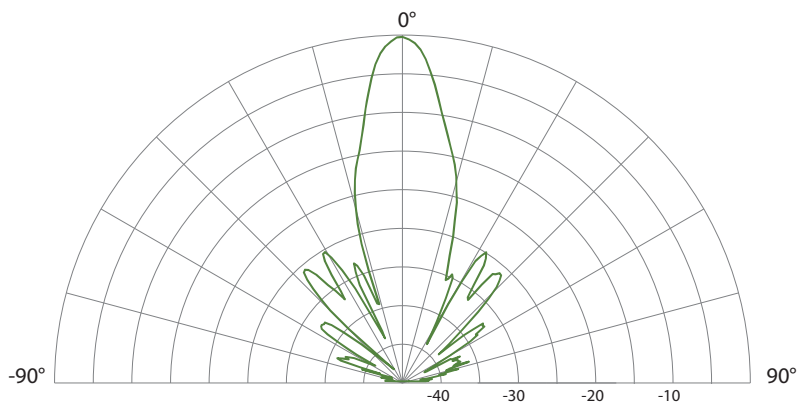

Elevation (measured @61GHz)

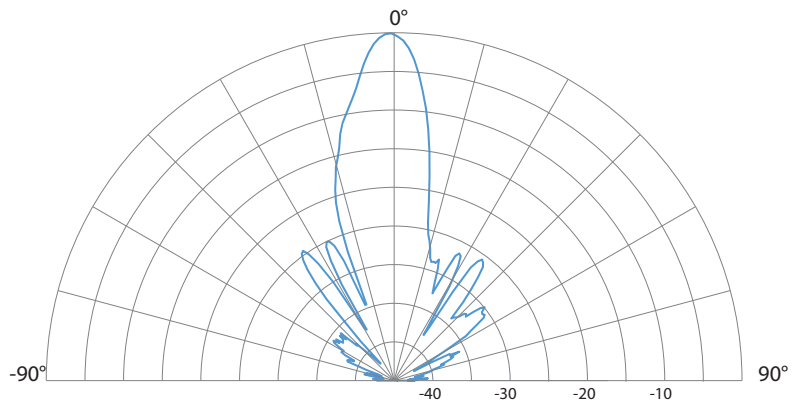

PARAMETER	CONDITIONS	SYMBOL	MIN	TYP	MAX	UNITS
TX antenna pattern						
TX pattern (3dB width)	horizontal	azimuth	7	8	9	°
	vertical	elevation	7	8	9	°
side-lobe suppression	horizontal	azimuth			15	dB
	vertical	elevation			15	dB
squinting angle	horizontal	azimuth	-2	0	2	°
squinting angle	vertical	elevation	-2	0	2	°

CONFIDENTIAL AND PROPRIETARY

The information contained in this document shall remain the sole and exclusive property of InnoSenT GmbH and shall not be disclosed by the recipient to third parties without prior consent of InnoSenT in writing.

MEASUREMENT DISTANCE DEFINITION

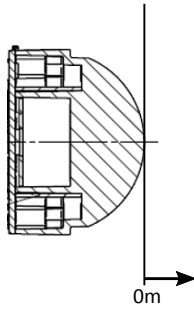

INTERFACE

Pin Headers, 1.27mm Pitch, Vertical, Double Row

The sensor provides an Connector type: W+P 7075-0XX-16-10-00-PPTR
 Compatible Female Headers is: W+P 6060-0XX-46-00-00-00-PPST

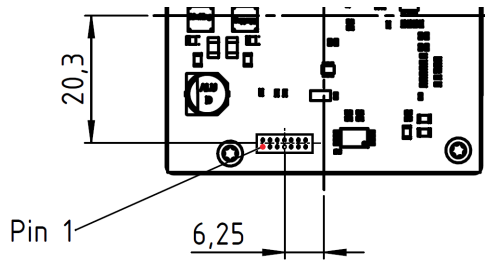
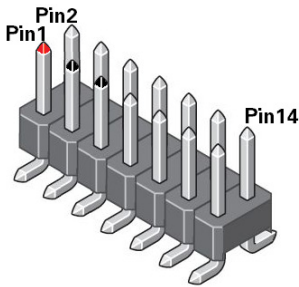

PIN #	DESCRIPTION	IN / OUT	COMMENT
1	V_IN	IN	5V Supply Voltage
2	SCI_RX	IN	UART Data in (3.3V)
3	GND		Ground
4	TX_ENABLE	OUT	TX_enable_RS485
5	GND		Ground
6	SCI_TX	OUT	UART Data Out (3.3V)
7	OUTPUT 3	OUT	Configurable Output
8	SPI_C_CS	OUT	(3.3V)
9	STATUS	OUT	High mean ready
10	SPI_C_MOSI	OUT	(3.3V)
11	OUTPUT 1	OUT	Configurable Output
12	SPI_C_CLK	OUT	(3.3V)
13	OUTPUT 2	OUT	Configurable Output
14	D.N.C		Do not connect

CUSTOMER INFORMATION

If the customer wants to realize RS-485, USB (RS-232) or a current interface on their board, do not hesitate to ask info@innosent.de for possible solutions. We gladly support you with schematic and/or layout recommendations.

CONFIDENTIAL AND PROPRIETARY

The information contained in this document shall remain the sole and exclusive property of InnoSenT GmbH and shall not be disclosed by the recipient to third parties without prior consent of InnoSenT in writing.

QUICK-START-GUIDE

For an easy start with the iSYS-6103 a quick-start-guide is available at <http://www.innosent.de/services/downloads/software-manuals/>

iSYS-6103 is a demo kit consisting of iSYS-6003, interface-board (RS485 or USB)



GUI - Graphical User Interface

The iSYS-6003 can be configured by using the corresponding GUI. The actual Software can be downloaded under <http://www.innosent.de/services/downloads/software-manuals/>



ESD-INFORMATION



This InnoSenT sensor is sensitive to damage from ESD. Normal precautions as usually applied to CMOS devices are sufficient when handling the device. Touching the signal output pins has to be avoided at any time before soldering or plugging the device into a motherboard.

APPROVAL

This Brief Description contains the technical specifications of the described product. Changes of the specification must be in written form. All previous versions of this Data Sheet are no longer valid.

VERSION	DATE	COMMENT
1.0	11.05.2016	initial release
1.1	07.11.2016	changing connector and mechanic
1.2	29.11.2016	adding ESD-Information
1.3	04.05.2017	adding Uart voltage level

InnoSenT GmbH

Am Rödertor 30
97499 Donnersdorf
GERMANY

Tel.: +49 (0)9528 - 9518 - 0
E-Mail: info@innosent.de
URL: www.innosent.de